

# Thyristors logic level

## BT169 series

### GENERAL DESCRIPTION

Glass passivated, sensitive gate thyristors in a plastic envelope, intended for use in general purpose switching and phase control applications. These devices are intended to be interfaced directly to microcontrollers, logic integrated circuits and other low power gate trigger circuits.

### QUICK REFERENCE DATA

SYMBOL	PARAMETER	MAX.	MAX.	MAX.	MAX.	UNIT
	<b>BT169</b>	<b>B</b>	<b>D</b>	<b>E</b>	<b>G</b>	
$V_{DRM}$ , $V_{RRM}$	Repetitive peak off-state voltages	200	400	500	600	V
$I_{T(AV)}$	Average on-state current	0.5	0.5	0.5	0.5	A
$I_{T(RMS)}$	RMS on-state current	0.8	0.8	0.8	0.8	A
$I_{TSM}$	Non-repetitive peak on-state current	8	8	8	8	A

### PINNING - TO92 variant

PIN	DESCRIPTION
1	anode
2	gate
3	cathode

### PIN CONFIGURATION

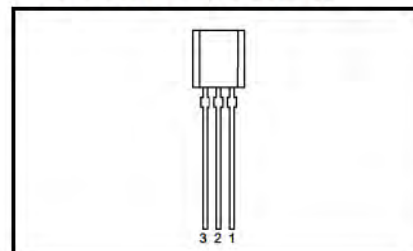

### SYMBOL

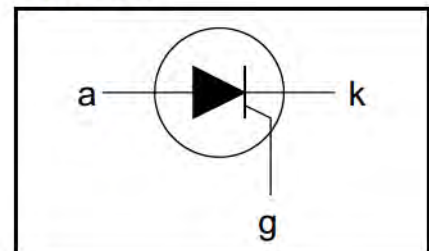

### LIMITING VALUES

Limiting values in accordance with the Absolute Maximum System (IEC 134).

SYMBOL	PARAMETER	CONDITIONS	MIN.	MAX.				UNIT
				B	D	E	G	
$V_{DRM}$ , $V_{RRM}$	Repetitive peak off-state voltages		-	200 <sup>1</sup>	400 <sup>1</sup>	500 <sup>1</sup>	600 <sup>1</sup>	V
$I_{T(AV)}$	Average on-state current	half sine wave; $T_{lead} \leq 83^\circ\text{C}$	-	0.5				A
$I_{T(RMS)}$	RMS on-state current	all conduction angles	-	0.8				A
$I_{TSM}$	Non-repetitive peak on-state current	$t = 10\text{ ms}$ $t = 8.3\text{ ms}$ half sine wave; $T_j = 25^\circ\text{C}$ prior to surge	-	8				A
			-	9				A
$I^2t$	$I^2t$ for fusing	$t = 10\text{ ms}$	-	0.32				A <sup>2</sup> s
$dl_T/dt$	Repetitive rate of rise of on-state current after triggering	$I_{TM} = 2\text{ A}$ ; $I_G = 10\text{ mA}$ ; $dl_G/dt = 100\text{ mA}/\mu\text{s}$	-	50				A/ $\mu\text{s}$
$I_{GM}$	Peak gate current		-	1				A
$V_{GM}$	Peak gate voltage		-	5				V
$V_{RGM}$	Peak reverse gate voltage		-	5				V
$P_{GM}$	Peak gate power		-	2				W
$P_{G(AV)}$	Average gate power	over any 20 ms period	-	0.1				W
$T_{stg}$	Storage temperature		-40	150				$^\circ\text{C}$
$T_j$	Operating junction temperature		-	125				$^\circ\text{C}$

<sup>1</sup> Although not recommended, off-state voltages up to 800V may be applied without damage, but the thyristor may switch to the on-state. The rate of rise of current should not exceed 15 A/ $\mu\text{s}$ .

Thyristors  
logic level

## BT169 series

## THERMAL RESISTANCES

SYMBOL	PARAMETER	CONDITIONS	MIN.	TYP.	MAX.	UNIT
$R_{th\ j-lead}$	Thermal resistance junction to lead		-	-	60	K/W
$R_{th\ j-a}$	Thermal resistance junction to ambient	pcb mounted; lead length = 4mm	-	150	-	K/W

## STATIC CHARACTERISTICS

 $T_j = 25\text{ }^\circ\text{C}$  unless otherwise stated

SYMBOL	PARAMETER	CONDITIONS	MIN.	TYP.	MAX.	UNIT
$I_{GT}$	Gate trigger current	$V_D = 12\text{ V}$ ; $I_T = 10\text{ mA}$ ; gate open circuit	-	50	200	$\mu\text{A}$
$I_L$	Latching current	$V_D = 12\text{ V}$ ; $I_{GT} = 0.5\text{ mA}$ ; $R_{GK} = 1\text{ k}\Omega$	-	2	6	mA
$I_H$	Holding current	$V_D = 12\text{ V}$ ; $I_{GT} = 0.5\text{ mA}$ ; $R_{GK} = 1\text{ k}\Omega$	-	2	5	mA
$V_T$	On-state voltage	$I_T = 1\text{ A}$	-	1.2	1.35	V
$V_{GT}$	Gate trigger voltage	$V_D = 12\text{ V}$ ; $I_T = 10\text{ mA}$ ; gate open circuit	-	0.5	0.8	V
		$V_D = V_{DRM(max)}$ ; $I_T = 10\text{ mA}$ ; $T_j = 125\text{ }^\circ\text{C}$ ; gate open circuit	0.2	0.3	-	V
$I_D, I_R$	Off-state leakage current	$V_D = V_{DRM(max)}$ ; $V_R = V_{RRM(max)}$ ; $T_j = 125\text{ }^\circ\text{C}$ ; $R_{GK} = 1\text{ k}\Omega$	-	0.05	0.1	mA

## DYNAMIC CHARACTERISTICS

 $T_j = 25\text{ }^\circ\text{C}$  unless otherwise stated

SYMBOL	PARAMETER	CONDITIONS	MIN.	TYP.	MAX.	UNIT
$dV_D/dt$	Critical rate of rise of off-state voltage	$V_{DM} = 67\% V_{DRM(max)}$ ; $T_j = 125\text{ }^\circ\text{C}$ ; exponential waveform; $R_{GK} = 1\text{ k}\Omega$	-	25	-	V/ $\mu\text{s}$
$t_{gt}$	Gate controlled turn-on time	$I_{TM} = 2\text{ A}$ ; $V_D = V_{DRM(max)}$ ; $I_G = 10\text{ mA}$ ; $dI_G/dt = 0.1\text{ A}/\mu\text{s}$	-	2	-	$\mu\text{s}$
$t_q$	Circuit commutated turn-off time	$V_D = 67\% V_{DRM(max)}$ ; $T_j = 125\text{ }^\circ\text{C}$ ; $I_{TM} = 1.6\text{ A}$ ; $V_R = 35\text{ V}$ ; $dI_{TM}/dt = 30\text{ A}/\mu\text{s}$ ; $dV_D/dt = 2\text{ V}/\mu\text{s}$ ; $R_{GK} = 1\text{ k}\Omega$	-	100	-	$\mu\text{s}$

Thyristors  
logic level

BT169 series

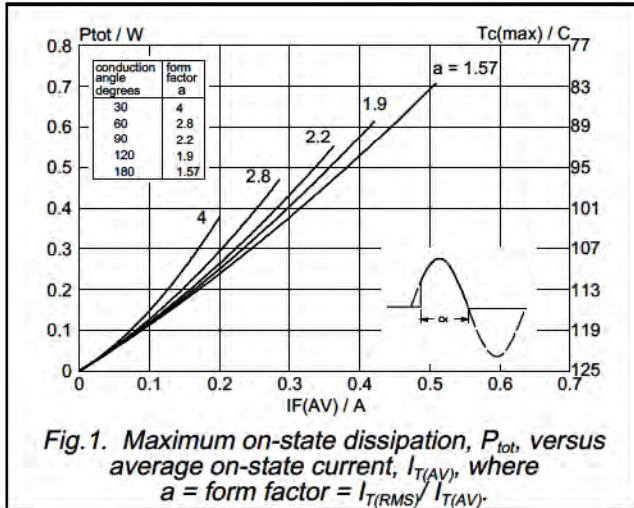

Fig. 1. Maximum on-state dissipation,  $P_{tot}$ , versus average on-state current,  $I_{T(AV)}$ , where  $a = \text{form factor} = I_{T(RMS)} / I_{T(AV)}$ .

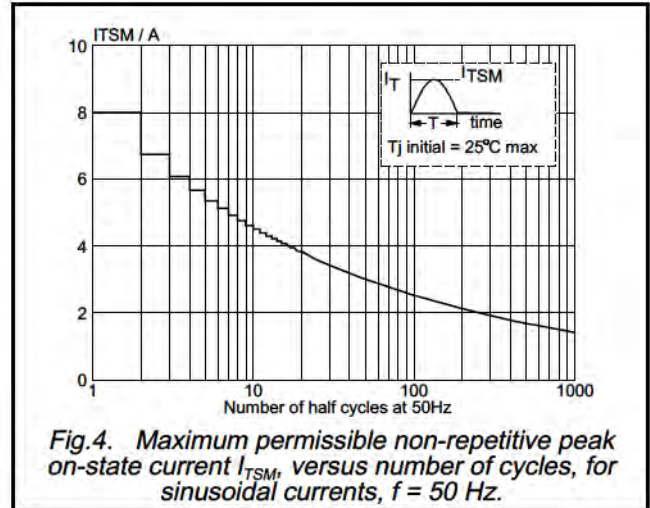

Fig. 4. Maximum permissible non-repetitive peak on-state current  $I_{TSM}$ , versus number of cycles, for sinusoidal currents,  $f = 50 \text{ Hz}$ .

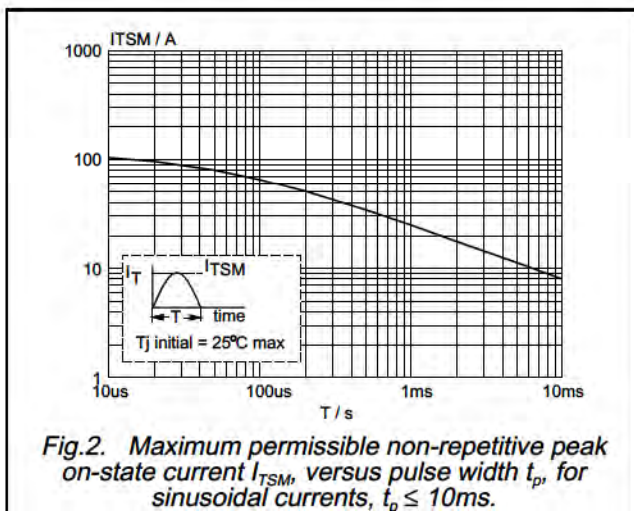

Fig. 2. Maximum permissible non-repetitive peak on-state current  $I_{TSM}$ , versus pulse width  $t_p$ , for sinusoidal currents,  $t_p \leq 10 \text{ ms}$ .

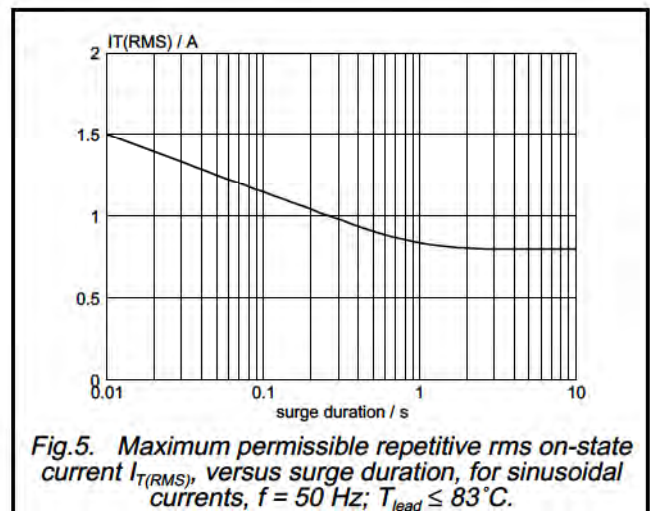

Fig. 5. Maximum permissible repetitive rms on-state current  $I_{T(RMS)}$ , versus surge duration, for sinusoidal currents,  $f = 50 \text{ Hz}$ ;  $T_{lead} \leq 83^\circ\text{C}$ .

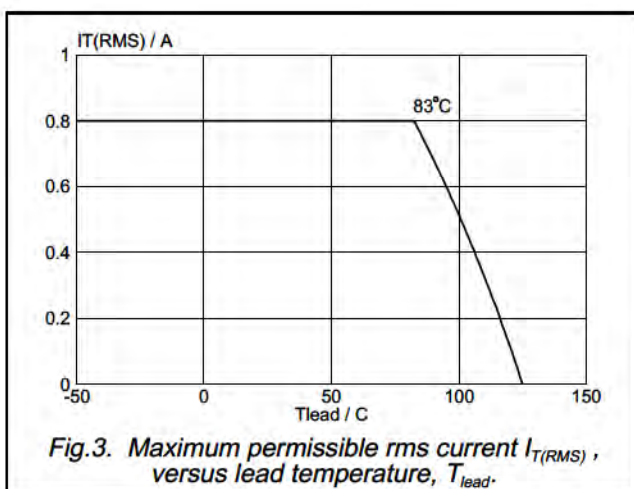

Fig. 3. Maximum permissible rms current  $I_{T(RMS)}$ , versus lead temperature,  $T_{lead}$ .

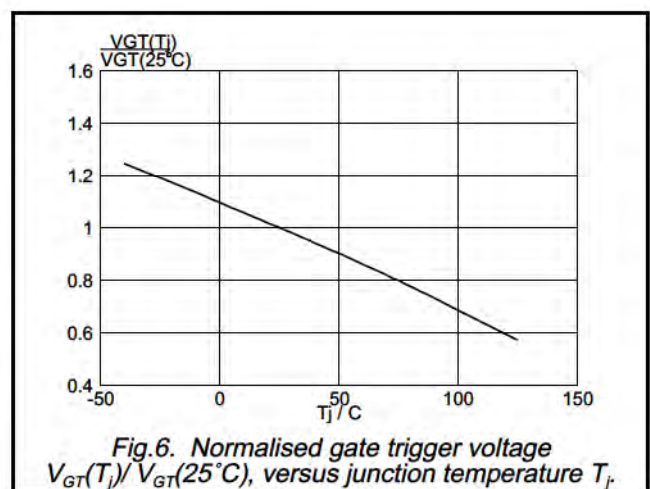
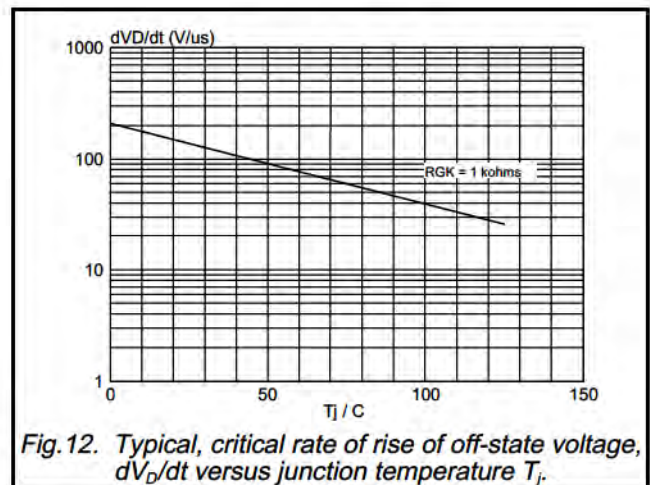
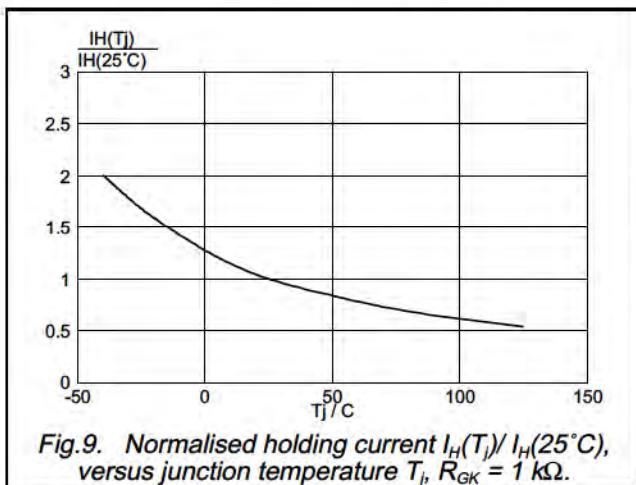
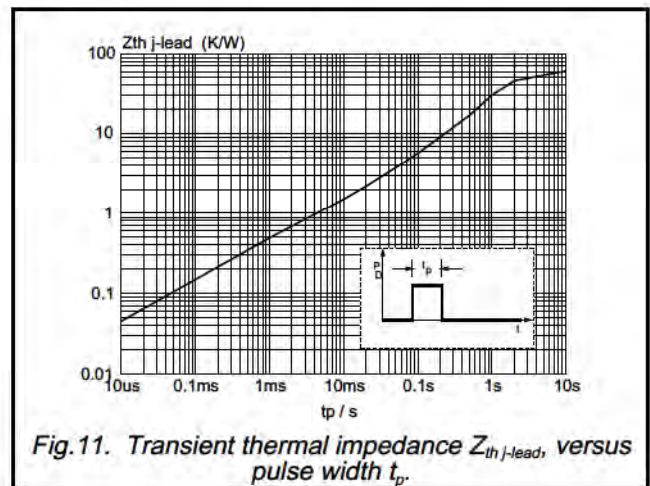
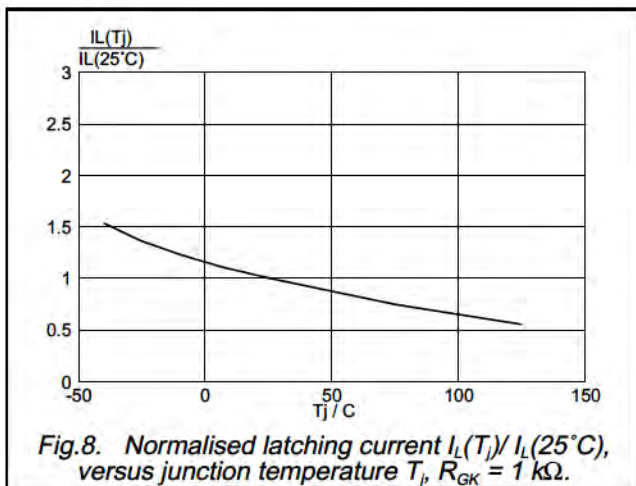
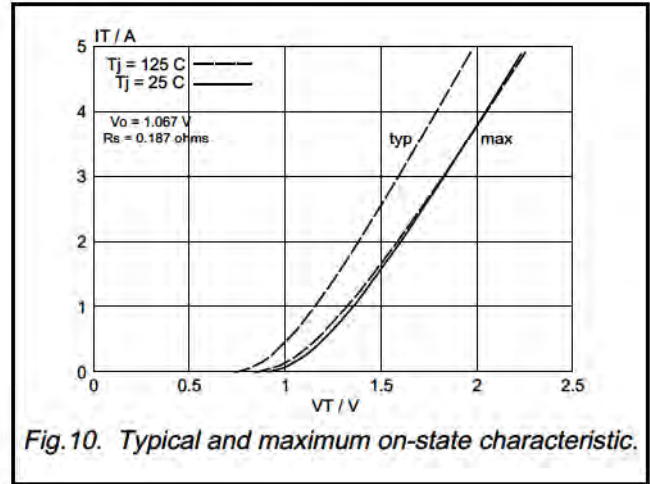
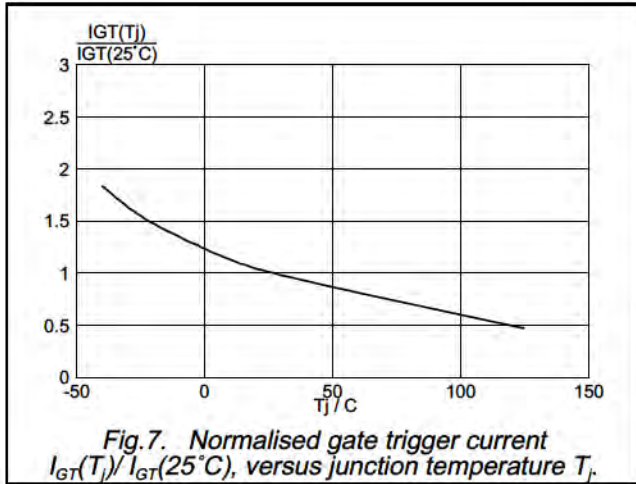

Fig. 6. Normalised gate trigger voltage  $V_{GT}(T_j) / V_{GT}(25^\circ\text{C})$ , versus junction temperature  $T_j$ .

Thyristors  
logic level

BT169 series



**MECHANICAL DATA**

Dimensions in mm

Net Mass: 0.2 g

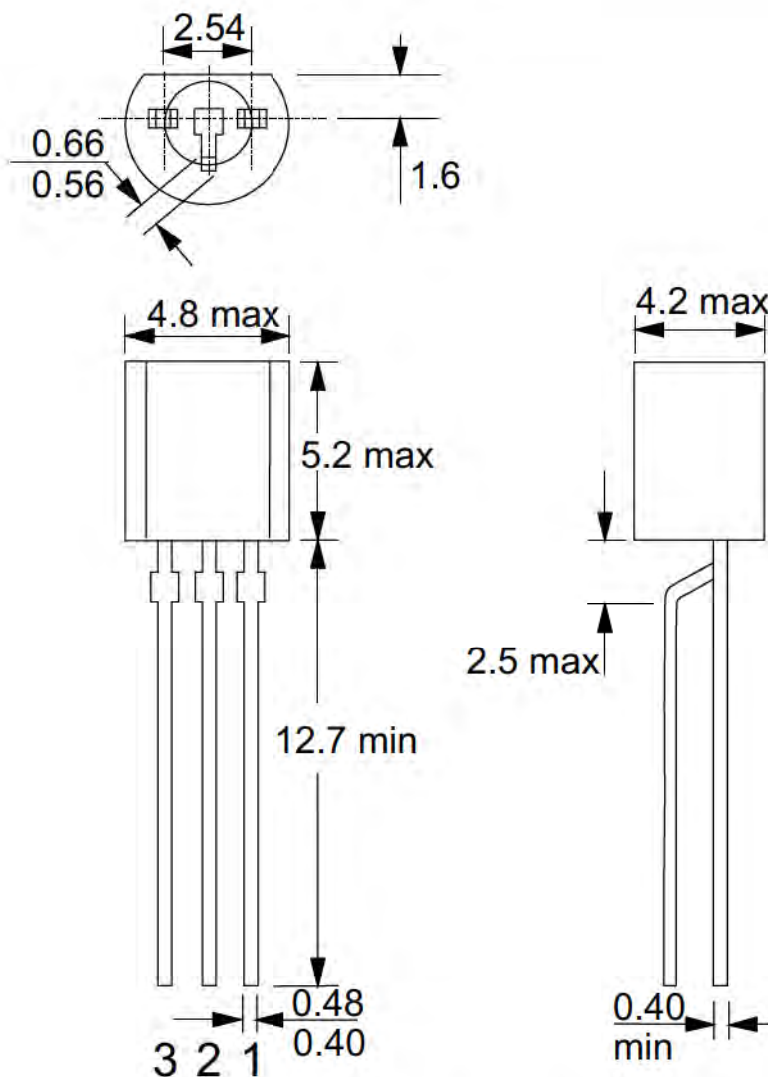

Fig.13. TO92; plastic envelope.

**Notes**

- 1. Epoxy meets UL94 V0 at 1/8".

Thyristors  
logic level

BT169 series

## DEFINITIONS

<b>Data sheet status</b>	
Objective specification	This data sheet contains target or goal specifications for product development.
Preliminary specification	This data sheet contains preliminary data; supplementary data may be published later.
Product specification	This data sheet contains final product specifications.
<b>Limiting values</b>	
Limiting values are given in accordance with the Absolute Maximum Rating System (IEC 134). Stress above one or more of the limiting values may cause permanent damage to the device. These are stress ratings only and operation of the device at these or at any other conditions above those given in the Characteristics sections of this specification is not implied. Exposure to limiting values for extended periods may affect device reliability.	
<b>Application information</b>	
Where application information is given, it is advisory and does not form part of the specification.	
© Philips Electronics N.V. 1997	
All rights are reserved. Reproduction in whole or in part is prohibited without the prior written consent of the copyright owner.	
The information presented in this document does not form part of any quotation or contract, it is believed to be accurate and reliable and may be changed without notice. No liability will be accepted by the publisher for any consequence of its use. Publication thereof does not convey nor imply any license under patent or other industrial or intellectual property rights.	

## LIFE SUPPORT APPLICATIONS

These products are not designed for use in life support appliances, devices or systems where malfunction of these products can be reasonably expected to result in personal injury. Philips customers using or selling these products for use in such applications do so at their own risk and agree to fully indemnify Philips for any damages resulting from such improper use or sale.