

DS14C89A/DS14C89AT Quad CMOS Receiver

General Description

The DS14C89A/DS14C89AT, pin-for-pin compatible to the DS1489A/MC1489A, are receivers designed to interface data terminal equipment (DTE) with data circuit-terminating equipment (DCE). These devices translate levels conforming to EIA-232E and CCITT V.28 standards to TTL/CMOS logic levels.

The device is fabricated in low threshold CMOS metal gate technology. The device provides very low power consumption compared to their bipolar equivalents: 900 μ A (DS14C89A) versus 26 mA (DS1489A).

The DS14C89A/DS14C89AT provide on chip noise filtering which eliminates the need for external response control filter capacitors. When replacing the DS1489A with the DS14C89A/DS14C89AT, the response control filter pins can be tied high, low, or not connected.

Features

- Meets EIA/TIA-232-E and CCITT V.28 Standards
- Industrial Temperature Range
–40°C to +85°C—DS14C89AT
- LOW Power consumption
- On chip noise filter
- Available in SOIC Package

Connection Diagram

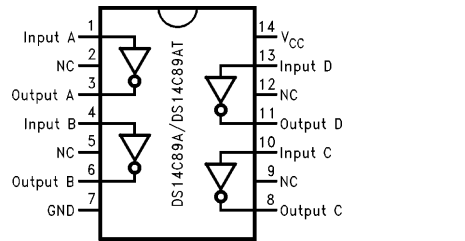

Order Number **DS14C89AN, DS14C89AM,
DS14C89ATJ, DS14C89ATN, DS14C89ATM**
See NS Package Number **J14A, M14A, N14A**

TL/F/11106-1

Absolute Maximum Ratings (Note 1)

If Military/Aerospace specified devices are required, please contact the National Semiconductor Sales Office/Distributors for availability and specifications.

V_{CC}	+6V
Input Voltage	-30V to +30V
Receiver Output Voltage	(V_{CC}) +0.3V to GND-0.3V
Junction Temperature	+150°C
Continuous Power Dissipation @ +25°C (Note 2)	
N Package	1513 mW
J Package	1935 mW
M Package	1063 mW

Lead Temp. (Soldering 4 seconds) +260°C
 Storage Temp. Range -65°C to +150°C
 ESD Rating \geq 1.8 kV, Typically \geq 2 kV
 (HMB, 1.5 k Ω , 100 pF)

Recommended Operating Conditions

	Min	Max	Units
V_{CC} (GND = 0V)	+4.5	+5.5	V
Operating Free Air Temp. (T_A)			
DS14C89A	0	+75	°C
DS14C89AT	-40	+85	°C

Electrical Characteristics Over recommended operating conditions, unless otherwise specified

Symbol	Parameter	Conditions	Min	Typ	Max	Units	
V_{TH}	Input High Threshold		1.3		2.7	V	
V_{TL}	Input Low Threshold		0.5		1.9	V	
V_{HY}	Typical Input Hysteresis			1.0		V	
I_{IN}	Input Current	$V_{IN} = +25V$	$V_{CC} = +4.5V$ to +5.5V	3.6		8.3	mA
		$V_{IN} = -25V$		-3.6		-8.3	mA
		$V_{IN} = +3V$		0.43		1.0	mA
		$V_{IN} = -3V$		-0.43		-1.0	mA
		$V_{IN} = +15V$	$V_{CC} = 0V$ (Power-Off) (Note 4)	2.14		5.0	mA
		$V_{IN} = -15V$		-2.14		-5.0	mA
		$V_{IN} = +3V$		0.43		1.0	mA
		$V_{IN} = -3V$		-0.43		-1.0	mA
V_{OH}	Output High Voltage	$V_{IN} = V_{TL}$ (min)	$I_{OUT} = -3.2$ mA	2.8	4.0		V
			$I_{OUT} = -20\mu A$	3.5	4.7		V
V_{OL}	Output Low Voltage	$V_{IN} = V_{TH}$ (max) $I_{OUT} = +3.2$ mA		0.15	0.4		V
I_{CC}	Supply Current	No Load $V_{IN} = 2.7V$ or 0.5V	DS14C89A		0.5	900	μA
			DS14C89AT		0.5	2.0	mA

AC Electrical Characteristics

Over recommended operating conditions, unless otherwise specified, $C_1 = 50$ pF (Note 3)

Symbol	Parameter	Conditions	Min	Typ	Max	Units
t_{PLH}	Propagation Delay Low to High	Input Pulse Width $\geq 10 \mu s$		3.5	6.5	μs
t_{PHL}	Propagation Delay High to Low	Input Pulse Width $\geq 10 \mu s$		3.2	6.5	μs
t_{SK}	Typical Propagation Delay Skew			400		ns
t_r	Output Rise Time			40	300	ns
t_f	Output Fall Time			40	300	ns
t_{NW}	Pulse Width assumed to be Noise				1.0	μs

Note 1: "Absolute Maximum Ratings" are those values beyond which the safety of the device cannot be guaranteed. They are not meant to imply that the devices should be operated at these limits. The tables of "Electrical Characteristics" specify conditions for device operation.

Note 2: Derate N Package 12.1 mW/°C, J Package 12.9 mW/°C, and M Package 8.5 mW/°C above +25°C.

Note 3: AC input waveforms for test purposes: $t_r = t_f = 200$ ns, $V_{IH} = +3V$, $V_L = -3V$, $f = 20$ KHz.

Note 4: Under the power-off supply conditions it is assumed that the power supply potential drops to zero (0V) and is replaced by a low impedance or short circuit to ground.

Parameter Measurement Information

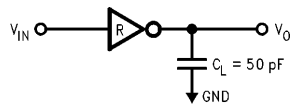

FIGURE 1: Receiver Load Circuit

TL/F/11106-2

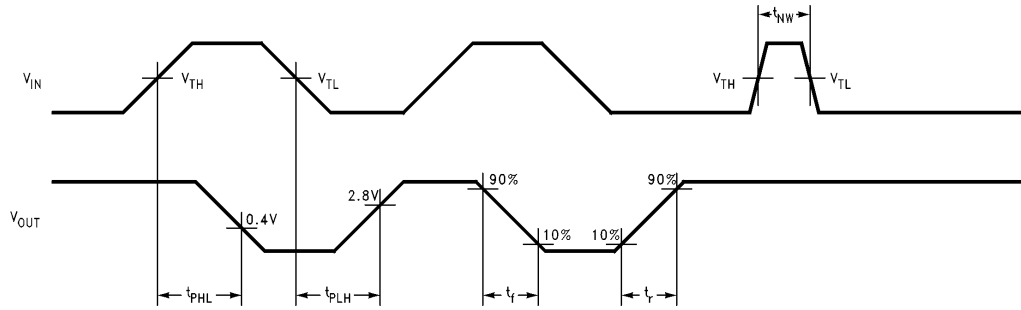

FIGURE 2: Receiver Switching Waveform (Note 3)

TL/F/11106-3

Typical Application Information

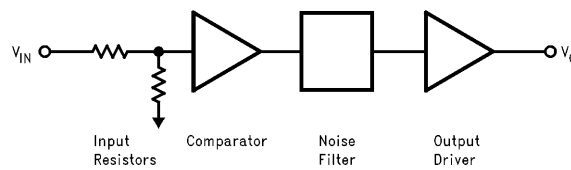

FIGURE 3. Receiver Block Diagram

TL/F/11106-4

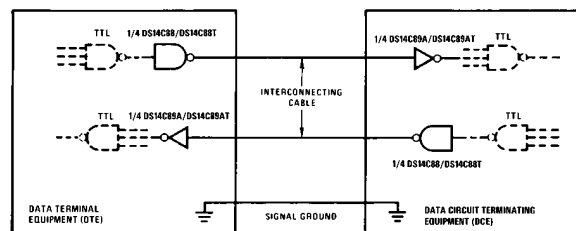
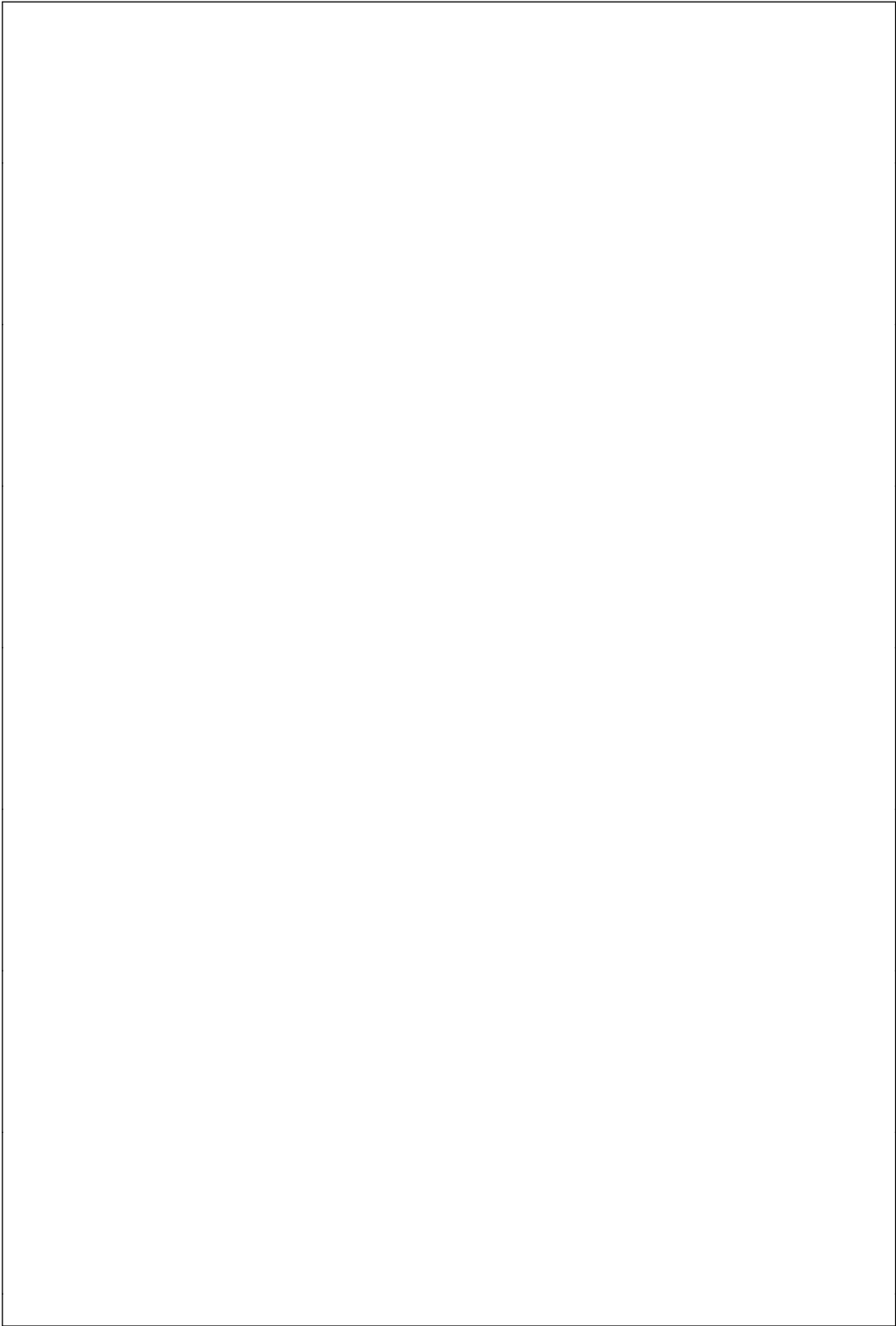
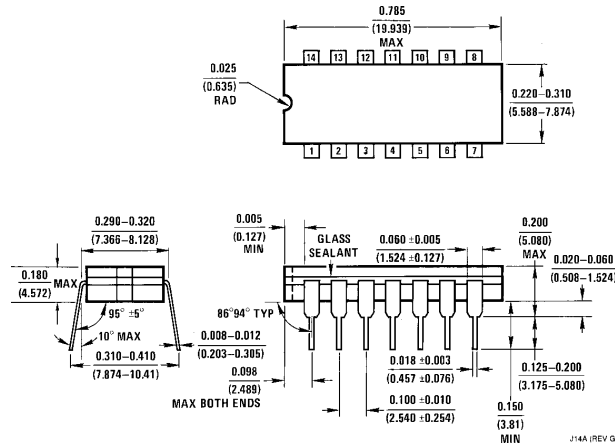

FIGURE 4. EIA-232D Data Transmission

TL/F/11106-5



Physical Dimensions inches (millimeters)



Order Number DS14C89ATJ
NS Package Number J14A

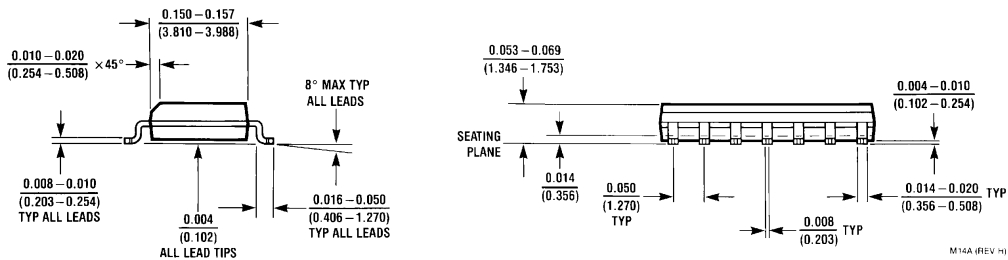
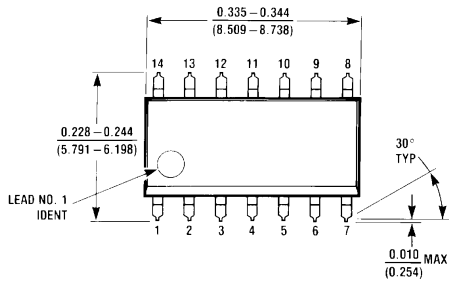

Order Number DS14C89AM or DS14C89ATM
NS Package Number M14A

Physical Dimensions inches (millimeters) (Continued)

Lit. # 103750

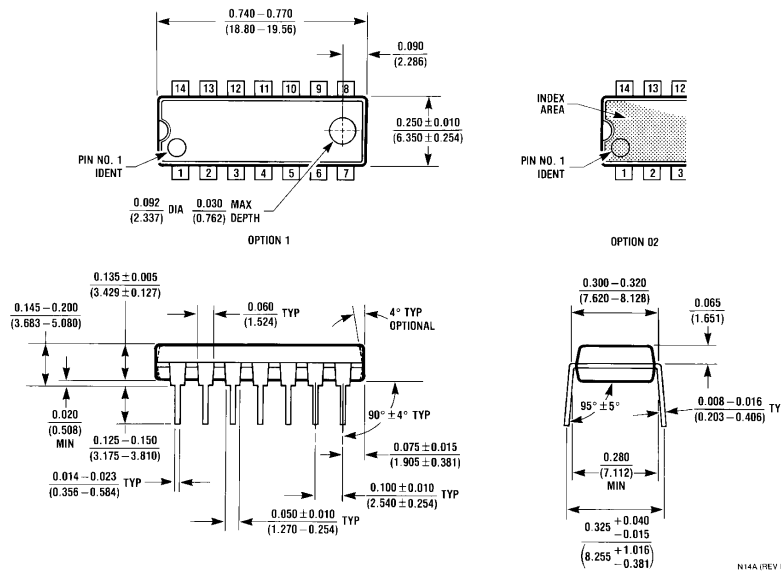

Order Number DS14C89AN or DS14C89ATN
NS Package Number N14A

LIFE SUPPORT POLICY

NATIONAL'S PRODUCTS ARE NOT AUTHORIZED FOR USE AS CRITICAL COMPONENTS IN LIFE SUPPORT DEVICES OR SYSTEMS WITHOUT THE EXPRESS WRITTEN APPROVAL OF THE PRESIDENT OF NATIONAL SEMICONDUCTOR CORPORATION. As used herein:

1. Life support devices or systems are devices or systems which, (a) are intended for surgical implant into the body, or (b) support or sustain life, and whose failure to perform, when properly used in accordance with instructions for use provided in the labeling, can be reasonably expected to result in a significant injury to the user.
2. A critical component is any component of a life support device or system whose failure to perform can be reasonably expected to cause the failure of the life support device or system, or to affect its safety or effectiveness.

 <p>National Semiconductor Corporation 1111 West Bardin Road Arlington, TX 76017 Tel: 1(800) 272-9959 Fax: 1(800) 737-7018 http://www.national.com</p>	<p>National Semiconductor Europe Fax: +49 (0) 180-530 85 86 Email: europe.support@nsc.com Deutsch Tel: +49 (0) 180-530 85 85 English Tel: +49 (0) 180-532 78 32 Français Tel: +49 (0) 180-532 93 58 Italiano Tel: +49 (0) 180-534 16 80</p>	<p>National Semiconductor Hong Kong Ltd. 19th Floor, Straight Block, Ocean Centre, 5 Canton Rd. Tsimshatsui, Kowloon Hong Kong Tel: (852) 2737-1600 Fax: (852) 2736-9960</p>	<p>National Semiconductor Japan Ltd. Tel: 81-043-299-2308 Fax: 81-043-299-2408</p>
--	--	---	---

National does not assume any responsibility for use of any circuitry described, no circuit patent licenses are implied and National reserves the right at any time without notice to change said circuitry and specifications.